

BATTEN LIGHT – MID POWER

MODEL: SCOTT – HJ – BAT – 80 – 1200

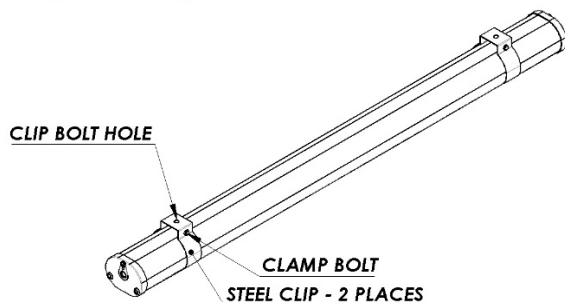

DIMENSIONS:

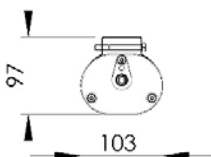
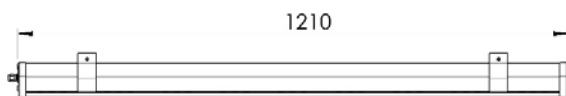

MOUNTING/FITTING DETAILS:

- Supplied with 2 steel clips with clamping bolts & M8 Bolts for mounting
- UL approved Power Cord (3X0.75mm²) – min 1.5 meters length

FEATURES:

- Luminous Efficacy - 120 lm/W
- Heat Sink – Finless extruded aluminium that allows for passive cooling and natural self-cleaning eliminating issues with dirt, dust, ice, snow or moisture resulting in longer fixture life.
- Built using high quality components (5 year warranty CE certified LED drivers & LM 80 certified LED's)
- Built in protective vents prevents condensation

TECHNICAL SPECIFICATIONS:

Model No	SCOTT – HJ – BAT – 80 – 900
Input Voltage	240V AC, 50/60 Hz
Power (Watt)	80
Luminous Flux	9600 LUMENS
CRI	> 70
Colour Temp (K)	5700CW (3000WW, 4000NW, 5000/6500 CW optional)
Power Factor	>0.91
THD	≤ 15.0%
Beam Angle	120°
IP rating	65
Dimmable	N/A
Life Span	>80, 000 hours
Materials	Extruded Aluminium
Finishing Colour	Black or White powder coated
Weight (kgs)	3.4
Control Gear	CE certified OEM Driver
LED Chip	LUMILEDS 3030 2D
Warranty	5 years
Operating Temp	-30°C to +40°C

APPLICATIONS

- Walkways/Corridor/Pathways/Plant growth/Alleys/Workshop/Work bench/Railway platforms
- Dirty/Dusty and harsh environments